

M15W Instruction Manual 4K ULTRA HD

PACKAGE CONTENTS

The items below are included with this product. If any item is missing, contact the dealer from whom you purchased this product.

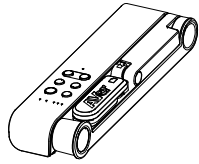

M15W unit



Power adapter/
Power plug

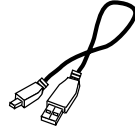

USB cable



Instruction manual



Wi-Fi Dongle

OPTIONAL ACCESSORIES



Carrying Bag

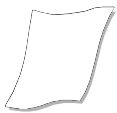

Anti-glare Sheet

MORE HELP

For FAQs, technical support, software and instruction manual download, please visit:

<https://www.averusa.com/education/support/>

HARDWARE PARTS

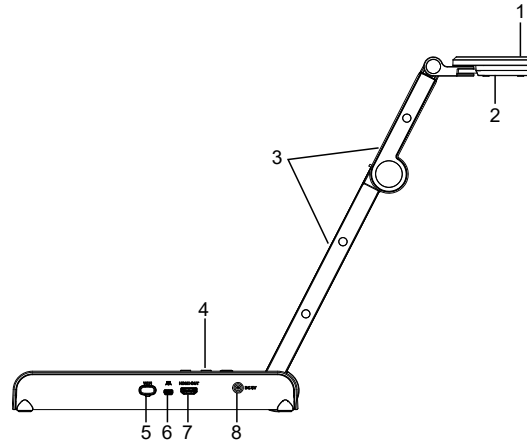

1. Camera head	2. LED lighting
3. Arm	4. Control panel
5. Wi-Fi dongle	6. USB port
7. HDMI output	8. DC power jack

CONTROL PANEL

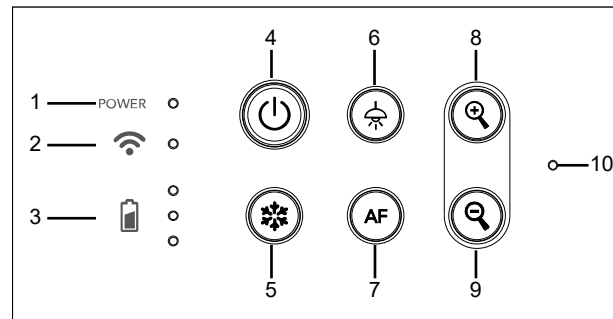

- | | |
|--------------------------------------|------------------|
| 1. Power indicator | 6. Lamp(on/off) |
| 2. Wi-Fi indicator | 7. Auto focus |
| 3. Battery indicator | 8. Zoom in |
| 4. Power button
(on/off/standby*) | 9. Zoom out |
| 5. Freeze | 10. Built-in MIC |

* Standby mode is supported when power plugged in.

LED INDICATOR

Power	<p>Solid green: Power on</p> <p>No light: Power off</p> <p>Solid red: Standby mode*</p> <p>* Standby mode is supported when power plugged in.</p>
Wi-Fi	<p>Solid blue: AP Mode Ready / STA connected</p> <p>Slow flashing blue: Software connection with camera</p> <p>Short flashing blue: Create AP mode / STA connecting</p> <p>Solid green: Miracast mode ready</p> <p>Slow flashing green: Miracast streaming start</p> <p>Quick flashing green: Miracast device scan / connecting</p>
Battery	<p>Solid green(x3): Battery is full(100% ~ 60%)</p> <p>Solid green(x2): Battery is 60% ~ 30%</p> <p>Solid green(x1): Battery is 30% ~ 5%</p> <p>Solid red (x1): Battery is 5% ~ 0%</p> <p>Flashing red (x1): Battery is out of power</p> <p>Solid orange(x3): Battery is abnormal</p>

[Note]

The battery will be exhausted for long-term usage. Do not replace the battery by yourself. Please contact your dealer.

COMPOUND KEY

Display system information and battery power status .

Snapshot the current screen image to software or cloud.

<p>PRESS & HOLD</p> <p>3 SECONDS</p> <p> MORE INFO / BATTERY</p> <p> CAPTURE</p>	<p>FACTORY RESET</p> <p> + </p> <p>RESOLUTION</p> <p> + </p> <p>MODE</p> <p> + </p>
--	--

COMPOUND KEY (Cont.)

Back to factory default settings.

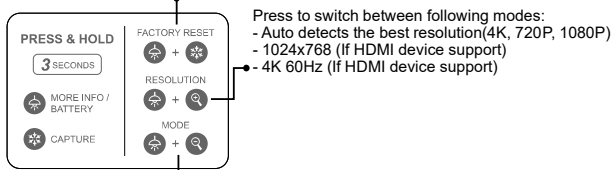

Press to switch between following modes:
 - Normal: Adjust the gradient of image.
 - Motion: Increase frame rate.
 Sufficient lighting is required when using this mode.
 - High quality: Better image quality.

DEVICE CONNECTION

1 Plug in power adapter and turn on M15W.

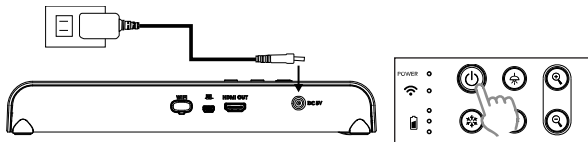

[Note]

- Please fully charge the camera for the first time use.
- When the camera is power on, the camera is in "Standby" mode. In standby mode, it can be charging with the USB connection between other devices; but the power supply is required 5V2A and the charging time will be longer.
- The laptop, projector, or monitor **cannot** provide the power through the USB connection to the camera while the camera is operating.
- When the camera is charging with the wall outlet, the battery indicator is in green flashing.
- Press (AF) + (Q) to reboot when the camera doesn't work properly.

2 Connect M15W to laptop and HDMI display.

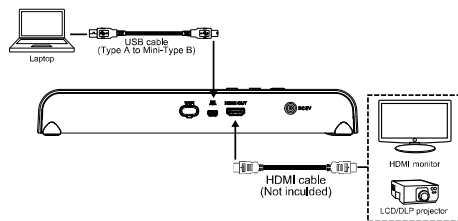

[Note]

- The Wi-Fi mode is on when the camera is powered up.
- When the camera connects to a laptop through the USB port, the Wi-Fi mode is disabled. Please follow the direction on HDMI device.

P2P connection via Wi-Fi Dongle

1 Plug-in the WiFi dongle to PC/laptop and install the AVerTouch application.

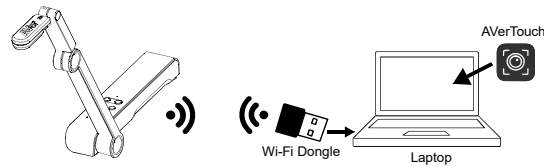

2 Open AVerTouch application, click [Refresh] to connect the camera.



[Note] Check serial number at bottom of the camera to find your camera.

3 Click Next to continue.

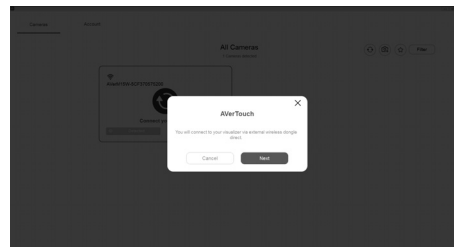

4 Entering the Camera Name and Passcode, click Done to continue.

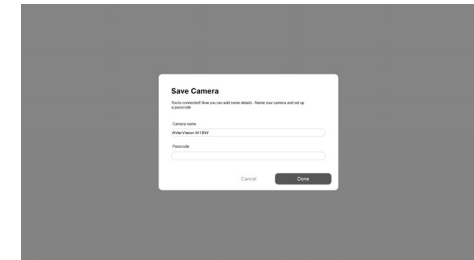

5 Click Done button to connect camera.

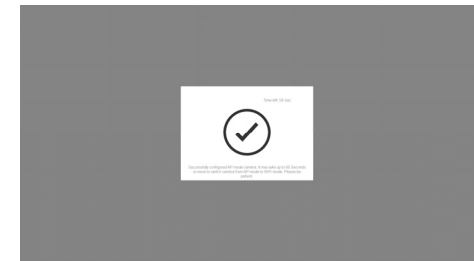

[Note] It takes about 60 seconds to complete connection.

6 Select X can exit the live view page.



[Note] When connecting is successful, you should see the live view of the camera.

Wi-Fi Connection

1

Power on the camera.

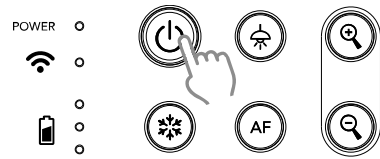

Check the Wi-Fi status – Blue light on.

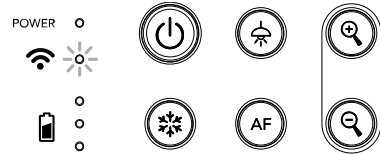

2

Open AVerTouch and follow on-screen instruction to enable Wi-Fi function on camera.

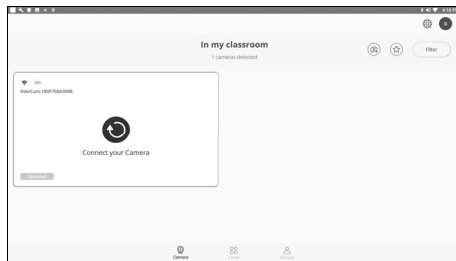

[Note]

- The software will auto detect the camera on your network.
- Select the camera that you want to connect with it.
- The camera name will be "AVer 'model name' - WiFi dongle Mac address". The Mac address will be different from the device.

3

Select to make a connection with camera.

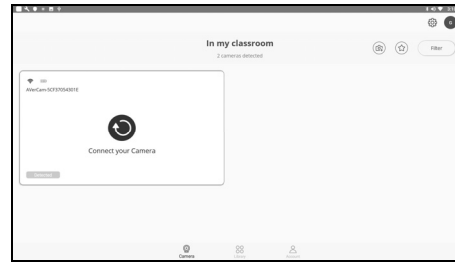

4

Select to switch to camera live screen.

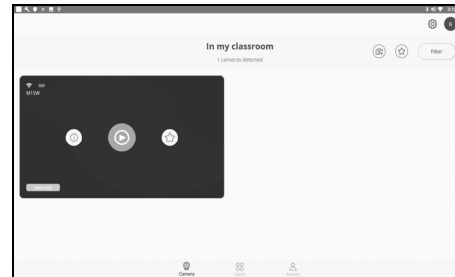

MIRACAST CONNECTION

1

Press to enter selection menu.

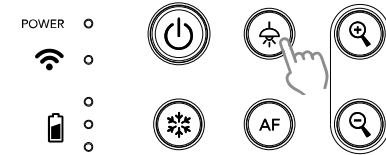

[Note]

- Using and button to go to the selection and press button to confirm the selection.
- A commercial Miracast Dongle (Wireless Adapter) is required for the display device.

2

Select Wireless > Mode > Miracast to enable Miracast mode.

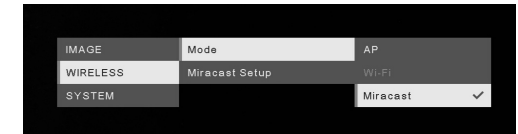

3

Select Miracast > display device.

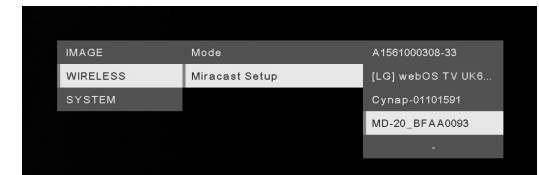

[Note]

- The detected display devices will be list out.
- Press back to the menu.
- The camera image will display on the display device's screen after connecting.

USING THE CAMERA

Storage the Camera

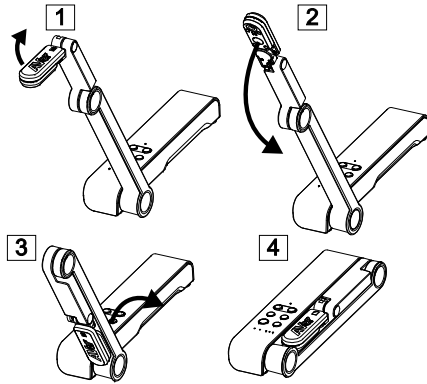

Using Angle of the Camera

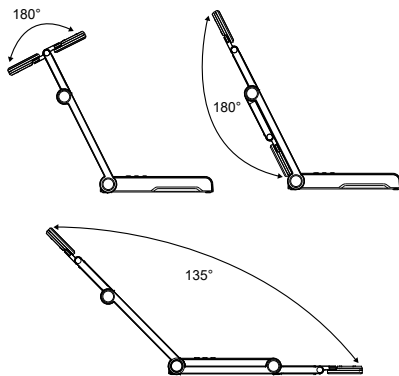

Mounting the Camera on a Flat Surface

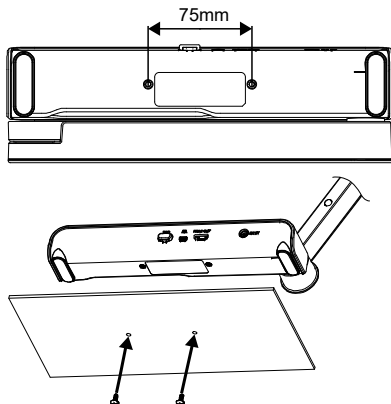

Rotate the Camera Head

Move the camera head as the figure shown.

[CAUTION] To avoid damage to the camera head, hold the edge of the camera head to rotate the camera head.

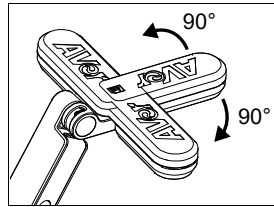

USING THE CAMERA(Cont.)

Shooting Area

When camera position is 330mm high, the shooting area will be A3 size. Place the object as illustrated show, the object image is in a positive direction.

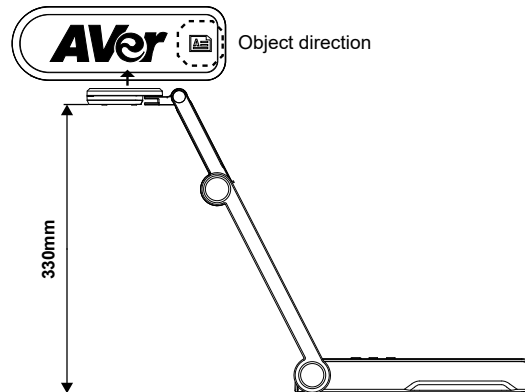
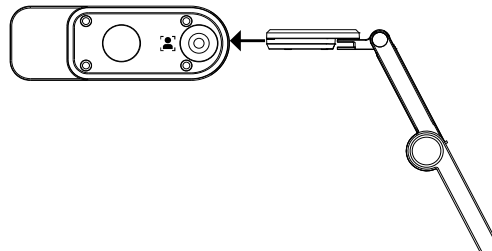

Image Shooting Direction

To shoot people, adjust the camera lens as illustrated shown; the person's image is in a positive direction.



SPECIFICATION

Sensor	1/3.06" CMOS
Pixel Count	13 megapixels
Frame Rate	60 fps (max.)
Image mode	Normal / High Frame / High Quality
Effect	Rotate / Freeze
HDMI Output	4K; 1080p 60Hz; 720p 60Hz
Focusing	Auto / Manual/ Area (SW)
Shooting Area	426mm x313mm @ 330 mm
Zooming	Total 23X maximum
Dual Mode	AP / Station DHCP(Server/Client)
WiFi Streaming	1080P@30fps, up to 4K@30fps
Dual Band	5GHz/2.4GHz
Miracast	Yes
Compatibility	802.11a/b/g/n/ac (45 ft effective range)
Wireless Security	SUPPORT WEP, WPA/WPA2-PSK, WPA/WPA2-Enterprise* *EAP-PEAP, EAP-TLS
Power Source	DC5V/ 2A, AC 100-240V
Consumption	4 Watts(lamp on) 3.5 Watts(lamp off)
Lamp Type	LED light
USB	USB2.0 Type-A(WiFi Dongle) USB Type mini-B x 1
DC 5V Input	Power Jack
MIC	Built-in
Operating	518mm(L)*84 mm(W)*351mm(H) (+/-2mm include rubber foot)
Folded	280mm(L)*84mm(W)*42mm(H) (+/-2mm include rubber foot)
Weight	0.68 kg (about 1.5lbs)
Software Supported	ePTZ Image/ Area capture Picture by Picture Timer Cloud library Recording Annotation

Federal Communications Commission Statement

NOTE: This equipment has been tested and found to comply with the limits for a Class A digital device, pursuant to part 15 of the FCC Rules. These limits are designed to provide reasonable protection against harmful interference when the equipment is operated in a commercial environment. This equipment generates, uses, and can radiate radiofrequency energy and, if not installed and used in accordance with the instruction manual, may cause harmful interference to radio communications. Operation of this equipment in a residential area is likely to cause harmful interference in which case the user will be required to correct the interference at his own expense.

FCC Caution: Any changes or modifications not expressly approved by the party responsible for compliance could void the user's authority to operate this equipment.

This device complies with part 15 of the FCC Rules.

Operation is subject to the following two conditions:

- (1) This device may not cause harmful interference, and
- (2) this device must accept any interference received, including interference that may cause undesired operation.

CE Class A

Warning:

This is a class A product. In a domestic environment this product may cause radio interference in which case the user may be required to take adequate measures.

NOTICE

SPECIFICATIONS ARE SUBJECT TO CHANGE WITHOUT PRIOR NOTICE. THE INFORMATION CONTAINED HEREIN IS TO BE CONSIDERED FOR REFERENCE ONLY.

COPYRIGHT

©2020 AVer Information Inc. All rights reserved.

TRADEMARKS

"AVer" is a trademark owned by AVer Information Inc. Other trademarks used herein for description purpose only belong to each of their companies.

CAUTION

Risk of Explosion if Battery is replaced by an Incorrect Type. Dispose of Used Batteries According to the Instructions.

WARNING

- To reduce the risk of fire or electric shock, do not expose this appliance to rain or moisture. Warranty will be void if any unauthorized modifications are done to the product.
- Do not drop the camera or subject it to physical shock.
- Use the correct power supply voltage to avoid the damaging camera.
- Do not place the camera where the cord can be stepped on as this may result in fraying or damage to the lead or the plug.
- Hold the bottom of the camera with both hands to move the camera. Do not grab the lens or Flexible arm to move the camera.
- Do not pull the mechanical arm and camera part in the opposite direction.

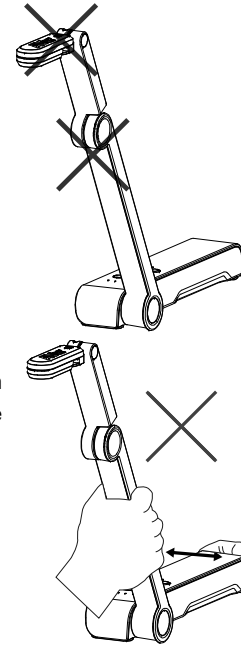

RADIO FREQUENCY

FOR PORTABLE DEVICE USAGE (<20m from body/SAR needed eg. BT dongle, smartphone)

Radiation Exposure Statement:

The product complies with the FCC portable RF exposure limit set forth for an uncontrolled environment and are safe for intended operation as described in this manual. The further RF exposure reduction can be achieved if the product can be kept as far as possible from the user body or set the device to lower output power if such function is available.

FOR MOBILE DEVICE USAGE (>20cm/low power eg. AP routers)

Radiation Exposure Statement:

This equipment complies with FCC radiation exposure limits set forth for an uncontrolled environment. This equipment should be installed and operated with minimum distance 20cm between the radiator & your body.

RADIO FREQUENCY

Europe – EU Declaration of Conformity

This device complies with the essential requirements of the Radio Equipment Directive (2014/53/EU). The following test methods have been applied in order to prove presumption of conformity with the essential requirements of the Radio Equipment Directive (2014/53/EU)

DISCLAIMER

No warranty or representation, either expressed or implied, is made with respect to the contents of this documentation, its quality, performance, merchantability, or fitness for a particular purpose. Information presented in this documentation has been carefully checked for reliability; however, no responsibility is assumed for inaccuracies. The information contained in this documentation is subject to change without notice.

In no event will AVer be liable for direct, indirect, special, incidental, or consequential damages arising out of the use or inability to use this product or documentation, even if advised of the possibility of such damages.



THE MARK OF CROSSED-OUT WHEELED BIN INDICATES THAT THIS PRODUCT MUST NOT BE DISPOSED OF WITH YOUR OTHER HOUSEHOLD WASTE. INSTEAD, YOU NEED TO DISPOSE OF THE WASTE EQUIPMENT BY HANDING IT OVER TO A DESIGNATED COLLECTION POINT FOR THE RECYCLING OF WASTE ELECTRICAL AND ELECTRONIC EQUIPMENT. FOR MORE INFORMATION ABOUT WHERE TO DROP OFF YOUR WASTE EQUIPMENT FOR RECYCLING, PLEASE CONTACT YOUR HOUSEHOLD WASTE DISPOSAL SERVICE OR THE SHOP WHERE YOU PURCHASED THE PRODUCT.

CONTACT INFORMATION

AVer Information Inc.

www.averusa.com

668 Mission Ct.

Fremont, CA 94539, USA

Toll-free: 1(877)528-7824

Local: 1(408)263-3828

Support.usa@aver.com

